

ES

Armario en madera. Modular i combinable con nuestra gama de armarios.

EN

Wood bookcase. Modular and mixable with our bookcase's range.

FR

Armoire bibliothèque en bois. Modulaire et combinable avec notre gamme d'armoires.

CAT

Armari llibreter en fusta. Modular i combinable amb la nostra gama d'armaris.

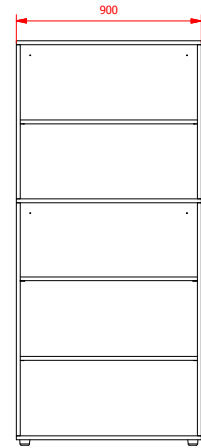
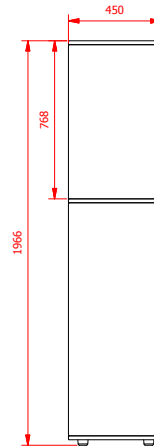

- 1 **Estructura de tablero de aglomerado de alta densidad de 19 mm de espesor, recubierto con papel melamínico blanco**
Structure made of 19 mm high-density chipboard with white-coloured melamine
Structure en panneau aggloméré haute densité de 19 mm d'épaisseur; couvert les deux côtés avec mélamine papier
Estructura de tauler d'aglomerat d'alta densitat de 19mm de gruix, recobert amb paper melamínic blanc

- 2 **4 tacos niveladores**
4 block levelers
4 taquets niveleurs
4 tacs anivellables

- 3 **Estantes regulable en altura**
Adjustable shelves
Étagères réglable
Prestatges regulable en alçada

COLOR / COLOUR / COULEUR / COLOR

ESTRUCTURA / STRUCTURE /
STRUCTURE / ESTRUCTURA



22

PESO
WEIGHT
POIDS
PES



40,60 kg

CANTIDAD DE EMBALAJE
PACK QUANTITY
QTÉ D'UNITÉS PAR CARTON
QUANTITAT D'EMBALATGE

1

EMBALAJE
CARTON BOX
CARTON
EMBALATGE

6

ES	EN	FR	CAT
Nuestros productos estan diseñados y fabricados según las normativas de aplicación correspondientes.	Our products are designed and manufactured according to the corresponding implementation regulations.	Nos produits sont conçus et fabriqués selon les normatives d'application correspondantes. Relation des normes applicables.	Els nostres productes estan dissenyats i fabricats segons les normatives d'aplicació corresponents.
INFORMACIÓN IMPORTANTE Lea todas las instrucciones antes de comenzar el ensamblaje. Guarde las instrucciones para uso futuro.	IMPORTANT INFORMATION Read all instructions before beginning assembly. Keep instructions for future use.	INFORMATION IMPORTANTE Lisez toutes les instructions de montage avant de commencer l'assemblage. Gardez les instructions pour toute éventuelle future utilisation.	INFORMACIÓ IMPORTANT Llegeixi totes les instruccions abans de començar el muntatge. Guardi les instruccions per un ús futur.
SUGERENCIA DE USO Movable, ideal para la flexibilidad del aula, espacios comunes. Permite múltiples configuraciones para entornos de trabajo colaborativo. Uso interior.	SUGGESTED USE Movable, ideal for the flexibility of the classroom, common spaces. Allows for multiple configurations for collaborative work environments. Indoor use.	CONSEILS D'UTILISATION Mobile, permet des multiples configurations pour des environnement de travail collaboratifs. Idéal pour la flexibilité des espaces communs, expositions, salles d'attente.	SUGGERIMENT D'ÚS Movable, ideal per a la flexibilitat de l'aula, espais comuns. Permet múltiples configuracions per a entorns de treball cooperatiu. Ús interior.
ADVERTENCIA Utilizar solo como se pretende. No intente ponerse de pie o arrodillarse sobre el artículo. No apilar. Solo combinaciones planas.	WARNING Use only as intended. Do not attempt to stand or kneel on item. Do not stack just flat join.	AVERTISSEMENT À être utilisé que pour l'objet dont il a été conçu. Ne pas se mettre debout ou s'agenouiller sur l'article. Uniquement des combinaisons horizontales.	ADVERTÈNCIA Utilitzar només pel seu ús. No intenti posar-se de peu o agenollar-se sobre l'article. No apilar. Només combinacions planes.
MONTAJE Ver instrucciones de montaje.	ASSEMBLY See assembly instruction.	ASSEMBLAGE Suivez les instructions de montage adjointes.	MUNTATGE Veure instruccions de muntatge.
MANTENIMIENTO Periódicamente se deben realizar tareas de mantenimiento revisando el estado del producto. Ver que todas las uniones están correctamente fijadas, en buen estado y funcionando. Compruebe si hay roturas periódicamente. Retire el producto del servicio cuando se produzca alguna condición que pueda considerarse insegura..	MAINTENANCE Regular maintenance tasks have to be realized by checking the product's conditions. It is important to check that unions are properly fixed, in good conditions and working properly. Check for breakage periodically. Remove the product from service when any condition develops that might deem operation unsafe.	ENTRETIEN Des tâches d'entretien doivent être réalisés périodiquement. Assurez-vous que tous les joints sont correctement fixés, en bon état et fonctionnent. Vérifiez si il y a des fissures. Empêchez l'utilisation du produit si vous observez toute condition qui puisse se considérer dangereuse ou non sure.	MANTENIMENT Periòdicament s'han de realitzar tasques de manteniment revisant l'estat del producte. Veure que totes les unions estan correctament fixades, en bon estat i funcionant. Comprovi si hi ha trencaments periòdicament. Retiri el producte del servei quan es produeixi alguna condició que es pugui considerar insegura.
CUIDADO Y LIMPIEZA Limpie la unidad con un paño húmedo o una esponja con agua tibia y jabón suave. Séquelo. No use limpiadores abrasivos, blanqueadores, solventes químicos y detergentes fuertes.	CARE AND CLEANING Clean the unit with a damp cloth or sponge using warm water and mild soap. Wipe dry. Do not use abrasive cleaners, bleach, chemical solvents, and strong detergents.	MAINTIEN ET NETTOYAGE Nettoyez l'unité à l'aide d'un chiffon humide ou une éponge avec de l'eau tiède et du savon doux. Séchez le. Ne pas utiliser de nettoyeurs abrasifs, blanchissants, solvants chimiques et détergent forts.	CURA I NETEJA Netegi l'article amb un drap humit o una esponja amb aigua tèbia i sabó suau. Eixugui'l. No utilitzis netejadors abrasius, blanquejadors, solvents químics o detergents forts.
GARANTÍA 2 años de garantía limitada.	WARRANTY 2-year limited warranty.	GARANTIE 2 ans de garantie limitée.	GAMMA DE PRODUCTES I GARANTIA 2 anys de garantia limitada.



CALIDAD CERTIFICADA
CERTIFIED QUALITY
QUALITÉ CERTIFIÉE
QUALITAT CERTIFICADA



ASSOCIATED N°01646
AIDIMA
FURNITURE, WOOD AND PACKAGING
TECHNOLOGY INSTITUTE

MIRPLAY COLABORA CON LA ONG:
MIRPLAY COLLABORATES WITH NGO:
MIRPLAY PARTICIPE À L'ONG:
MIRPLAY COL·LABORA AMB L'ONG:

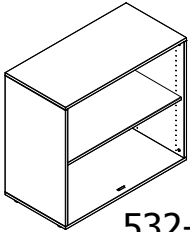

OXFAM
International

Instrucciones de montaje - Assembly instructions - Notice de montage - Instruccions de muntatge**532-501**

11-5301 x1
11-5302 x1
11-5303 x1

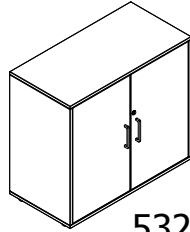
**532-502**

11-5301 x1
11-5302 x1
11-5303 x1
11-5304 x1

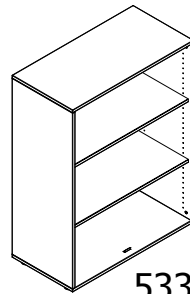
**533-501**

11-5301 x1
11-5305 x1
11-5306 x1

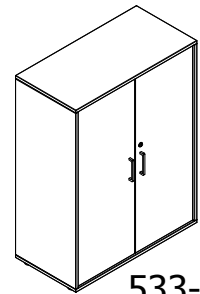
**533-502**

11-5301 - x1
11-5305 - x1
11-5306 - x1
11-5307 - x1

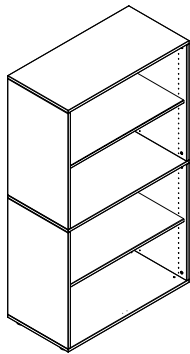
**534-501**

11-5301 x1
11-5302 x2
11-5303 x2
11-5308 x1

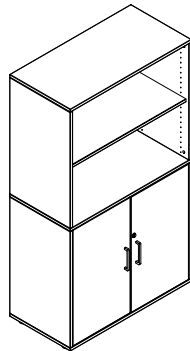
**534-508**

11-5301 x1
11-5302 x2
11-5303 x2
11-5304 x1
11-5308 x1

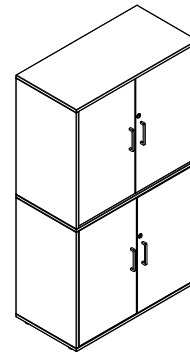
**534-509**

11-5301 x1
11-5302 x2
11-5303 x2
11-5304 x2
11-5308 x1

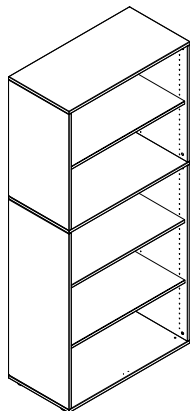
**535-501**

11-5301 x1
11-5302 x1
11-5303 x1
11-5305 x1
11-5306 x1
11-5308 x1

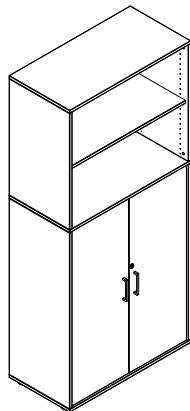
**535-508**

11-5301 x1
11-5302 x1
11-5303 x1
11-5305 x1
11-5306 x1
11-5307 x1
11-5308 x1

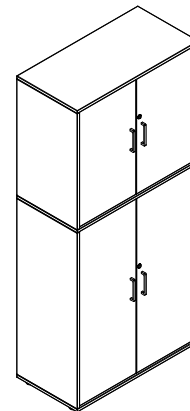
**535-521**

11-5301 x1
11-5302 x1
11-5303 x1
11-5304 x1
11-5305 x1
11-5306 x1
11-5307 x1
11-5308 x1

Instrucciones de montaje - Assembly instructions - Notice de montage - Instruccions de muntatge

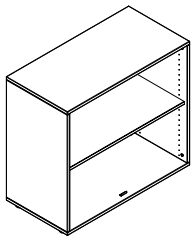

532-501

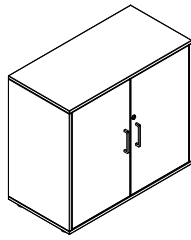

532-502

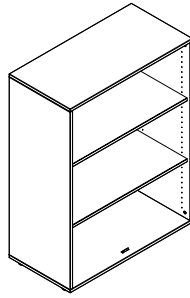

533-501

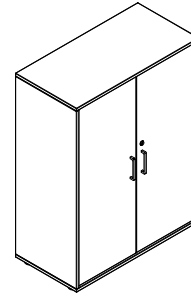

533-502

B
Base / Base / Base

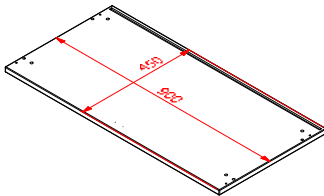

x4 x4

T
Tapa / Top / Couvercle

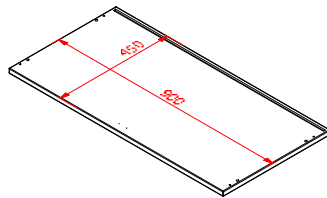

x4

C
Trasera / Back / Arriere

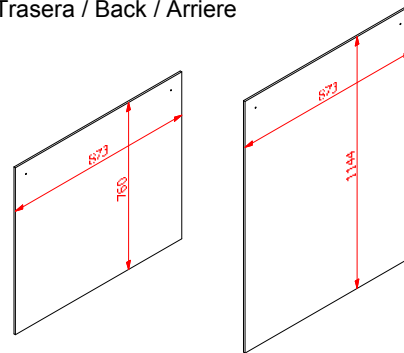

L
Lateral / Lateral Side / Latéral

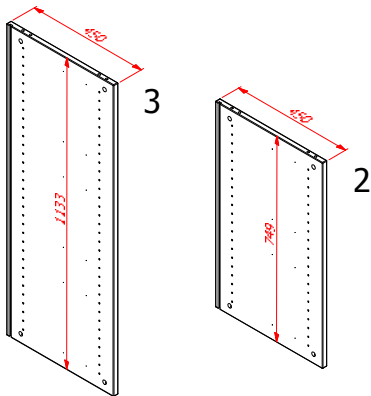

x4 x4

E
Estante / Shelf / Étagères

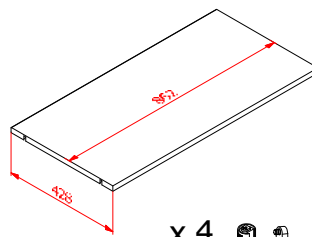

x4

P
Puerta / Doors / Portes

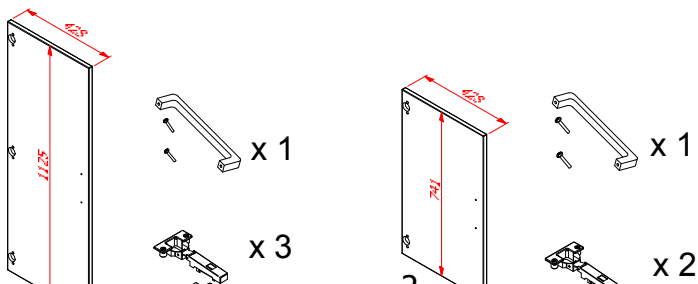

Instrucciones de montaje - Assembly instructions - Notice de montage - Instruccions de muntatge

T
Tapa / Top / Couvercle

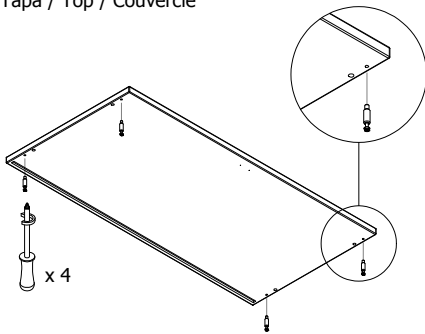

B
Base / Base / Base

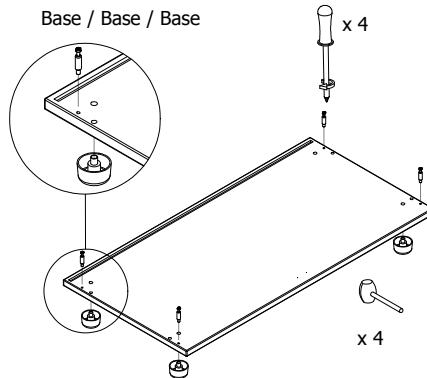

F
Estante fijo / Fixed shelf / Étagères fixe

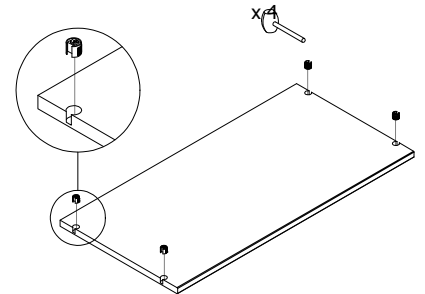

L
Laterales / Lateral / Latéral

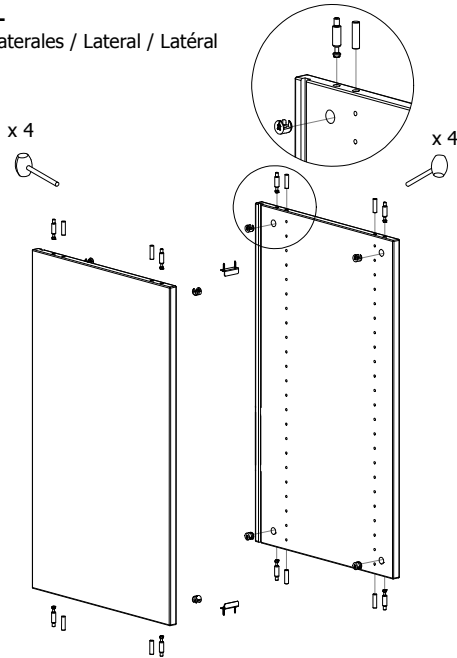

Z
Armazón / Frame / Cadre

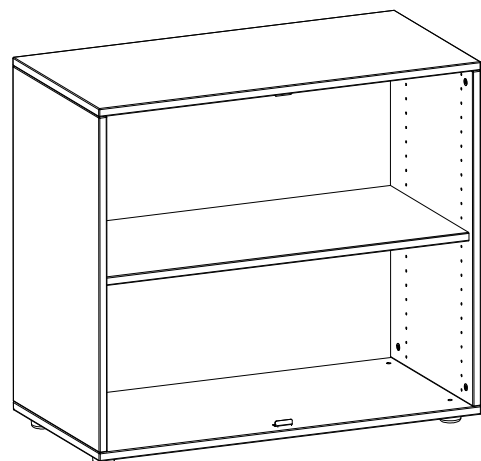
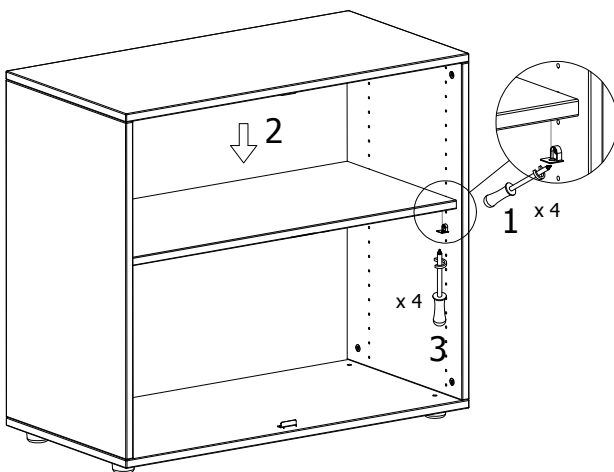
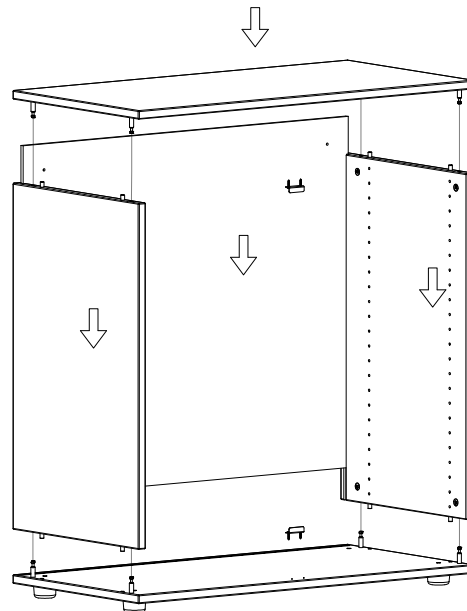

Instrucciones de montaje - Assembly instructions - Notice de montage - Instruccions de muntatge

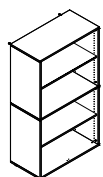

534-501

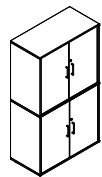

534-509

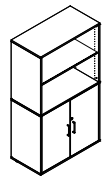

534-508

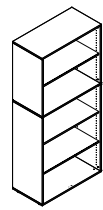

535-501

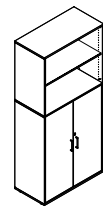

535-508

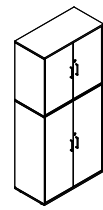

535-521

